

TEVAL

TECHNICAL VALVES

PRODUCT CATALOGUE

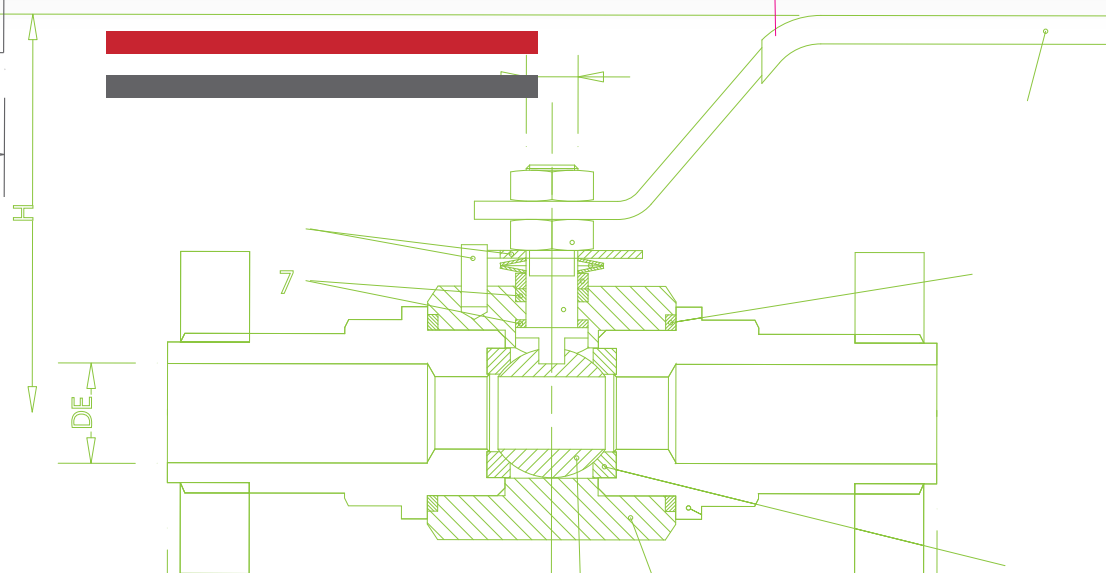

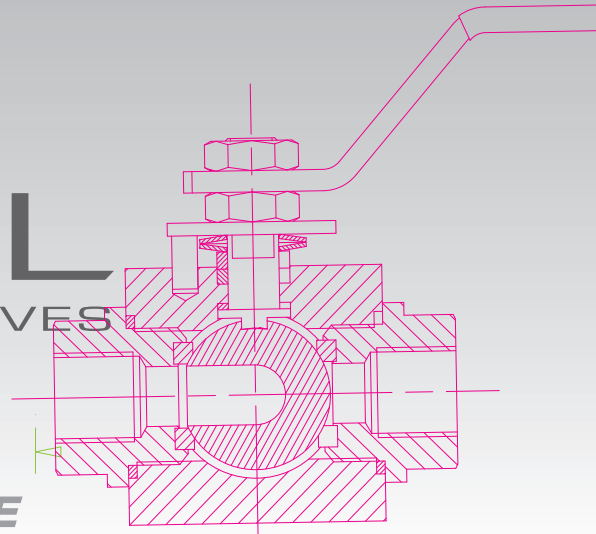
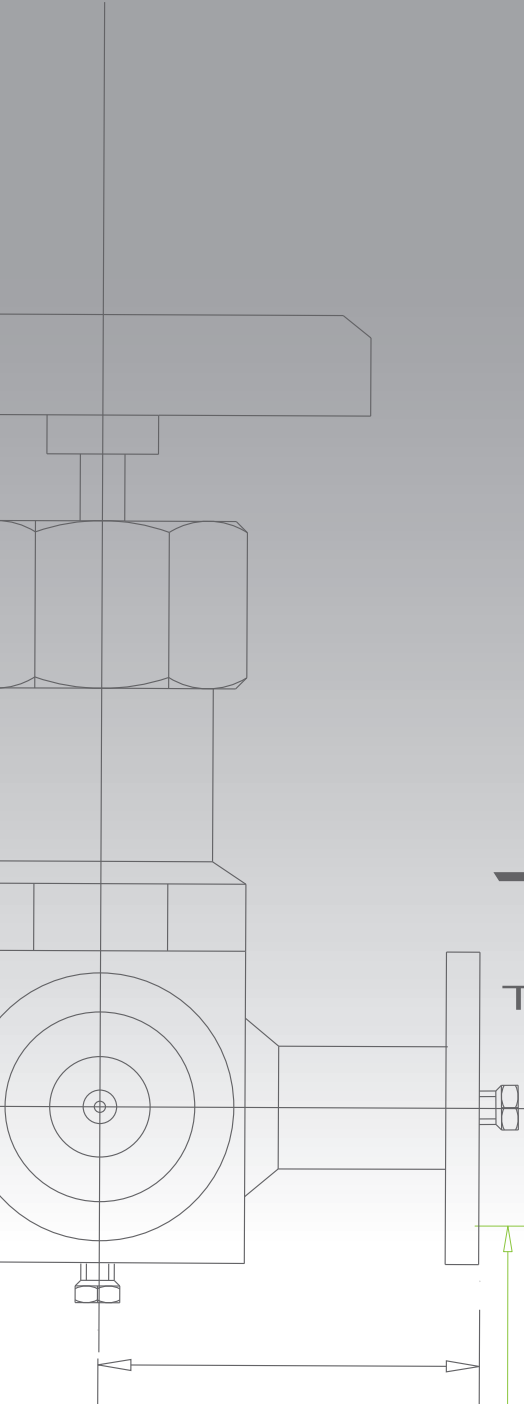



BALL VALVES

| POS/PG | TYPE | CLASSIFICATION | DRAWING CODE | FLUID PASSAGE SPECIFICATION | PRESSURE CLASS (LBS) | PRESSURE CLASS (PSI) | DIAMETERS | CONNECTIONS/ ENDS | THREAD |
|---|------------|--|--------------|---|----------------------|----------------------|-----------------|---------------------|--------|
| 1 | BALL VALVE | 2-PIECE MONOBLOCK | SF01 | FULL BORE | 600-800 1500 | 1500 3000 | FROM 1/4" TO 4" | NPT BSPP BSPT | F/F |
| MATERIAL | | SEATS | | SPECIAL EXECUTIONS | | | | | |
| STAINLESS STEEL 316 STAINLESS STEEL 304 CARBON STEEL LF2 CARBON STEEL A105 CARBON STEEL A105 DUPLEX SS STEEL F51 BRONZE ALUMINIUM-BRONZE MONEL400 | | PTFE PTFE+GLASS PTFE + CARBONGRAPHITE DELRIN PEEK KEL-F DEVLON | | STAINLESS STEEL LEVERS AND BOLTS STEM EXTENSION PADLOCKING DEVICES OVAL HANDWHEELS CONSTRUCTION FOR ACTUATOR OPERATION SEAL WELDING FULLY WELDING COMBINED CONNECTIONS (EX.BSP- F/SW) DEGREASING FOR OXYGEN SERVICE TAILOR-MADE LENGTH PERSONALIZED MARKING SINGLE PRODUCT PACKAGING 1/8" DIAMETER REALIZATION SEATS AND GASKETS ON SPECIFIC REQUEST | | | | | |



| POS/PG | TYPE | CLASSIFICATION | DRAWING CODE | FLUID PASSAGE SPECIFICATION | PRESSURE CLASS (LBS) | PRESSURE CLASS (PSI) | DIAMETERS | CONNECTIONS/ ENDS | THREAD |
|---|------------|--|--------------|---|----------------------|----------------------|-----------------|---------------------|--------|
| 2 | BALL VALVE | 2-PIECE MONOBLOCK | SF01/MF | FULL BORE | 600-800 1500 | 1500 3000 | FROM 1/4" TO 4" | NPT BSPP BSPT | M/F |
| MATERIAL | | SEATS | | SPECIAL EXECUTIONS | | | | | |
| STAINLESS STEEL 316 STAINLESS STEEL 304 CARBON STEEL LF2 CARBON STEEL A105 CARBON STEEL A105 DUPLEX SS STEEL F51 BRONZE ALUMINIUM-BRONZE MONEL400 | | PTFE PTFE+GLASS PTFE + CARBONGRAPHITE DELRIN PEEK KEL-F DEVLON | | STAINLESS STEEL LEVERS AND BOLTS STEM EXTENSION PADLOCKING DEVICES OVAL HANDWHEELS CONSTRUCTION FOR ACTUATOR OPERATION SEAL WELDING FULLY WELDING COMBINED CONNECTIONS (EX.BSP- M/SW) SCHEDULE VARIATION DEGREASING FOR OXYGEN SERVICE TAILOR-MADE LENGTH PERSONALIZED MARKING SINGLE PRODUCT PACKAGING 1/8" DIAMETER REALIZATION SEATS AND GASKETS ON SPECIFIC REQUEST | | | | | |



| POS/PG | TYPE | CLASSIFICATION | DRAWING CODE | FLUID PASSAGE SPECIFICATION | PRESSURE CLASS (LBS) | PRESSURE CLASS (PSI) | DIAMETERS | CONNECTIONS/ ENDS | THREAD |
|---|------------|--|--------------|--|----------------------|----------------------|-----------------|---------------------|--------|
| 3 | BALL VALVE | 3-PIECE MONOBLOCK | SF01 M2T | FULL BORE | 600-800 1500 | 1500 3000 | FROM 1/4" TO 4" | NPT BSPP BSPT | M/M |
| MATERIAL | | SEATS | | SPECIAL EXECUTIONS | | | | | |
| STAINLESS STEEL 316 STAINLESS STEEL 304 CARBON STEEL LF2 CARBON STEEL A105 CARBON STEEL A105 DUPLEX SS STEEL F51 BRONZE ALUMINIUM-BRONZE MONEL400 | | PTFE PTFE+GLASS PTFE + CARBONGRAPHITE DELRIN PEEK KEL-F DEVLON | | STAINLESS STEEL LEVERS AND BOLTS STEM EXTENSION PADLOCKING DEVICES OVAL HANDWHEELS CONSTRUCTION FOR ACTUATOR OPERATION SEAL WELDING FULLY WELDING DEGREASING FOR OXYGEN SERVICE TAILOR-MADE LENGTH PERSONALIZED MARKING SINGLE PRODUCT PACKAGING 1/8" DIAMETER REALIZATION SEATS AND GASKETS ON SPECIFIC REQUEST | | | | | |







TEVAL
TECHNICAL VALVES

BALL VALVES

| POS/PG | TYPE | CLASSIFICATION | DRAWING CODE | FLUID PASSAGE SPECIFICATION | PRESSURE CLASS (LBS) | PRESSURE CLASS (PSI) | DIAMETERS | CONNECTIONS/ ENDS | THREAD |
|--|------------|---|--------------|---|----------------------|----------------------|-----------------|-------------------|--------|
| 4 | BALL VALVE | 2-PIECE MONOBLOCK | SF01.SW | FULL BORE | 600-800 1500 | 1500 3000 | FROM 1/4" TO 4" | SW | |
| MATERIAL | | SEATS | | SPECIAL EXECUTIONS | | | | | |
| STAINLESS STEEL 316 STAINLESS STEEL 304 STEEL LF2 STEEL A105 STEEL A105 N STEEL F51 BRONZE ALUMINIUM - BRONZE MONEL400 | | PTFE PTFE +GLASS PTFE + CARBONGRAPHITE PEEK KEL-F DEVLON DELRIN | | STAINLESS STEEL LEVERS AND BOLTS STEM EXTENSION PADLOCKING DEVICES OVAL HANDWHEELS CONSTRUCTION FOR ACTUATOR OPERATION SEAL WELDING FULLY WELDING COMBINED CONNECTIONS (EX.BSP- F/SW) SCHEDULE VARIATION DEGREASING FOR OXYGEN USE TAILOR-MADE LENGTH PERSONALIZED MARKING SINGLE PRODUCT PACKAGING 1/8" DIAMETER REALIZATION SEATS AND GASKETS ON SPECIFIC REQUEST | | | | | |
|  | | | | | | | | | |

| POS/PG | TYPE | CLASSIFICATION | DRAWING CODE | FLUID PASSAGE SPECIFICATION | PRESSURE CLASS (LBS) | PRESSURE CLASS (PSI) | DIAMETERS | CONNECTIONS/ ENDS | THREAD |
|--|------------|---|--------------|---|----------------------|----------------------|-----------------|-------------------|--------|
| 5 | BALL VALVE | 2-PIECE MONOBLOCK | SF03 | FULL BORE | 600-800 1500 | 1500 3000 | FROM 1/4" TO 4" | BW | |
| MATERIAL | | SEATS | | SPECIAL EXECUTIONS | | | | | |
| STAINLESS STEEL 316 STAINLESS STEEL 304 STEEL LF2 STEEL A105 STEEL A105 N STEEL F51 BRONZE BRONZE-ALUMINIUM MONEL400 | | PTFE PTFE +GLASS PTFE + CARBONGRAPHITE DELRIN PEEK KEL-F DEVLON | | STAINLESS STEEL LEVERS AND BOLTS STEM EXTENSION PADLOCKING DEVICES OVAL HANDWHEELS CONSTRUCTION FOR ACTUATOR OPERATION SEAL WELDING FULLY WELDING COMBINED CONNECTIONS (EX.BSP- F/BW) SCHEDULE VARIATION DEGREASING FOR OXYGEN USE TAILOR-MADE LENGTH PERSONALIZED MARKING SINGLE PRODUCT PACKAGING 1/8" DIAMETER REALIZATION SEATS AND GASKETS ON SPECIFIC REQUEST | | | | | |
|  | | | | | | | | | |

| POS/PG | TYPE | CLASSIFICATION | DRAWING CODE | FLUID PASSAGE SPECIFICATION | PRESSURE CLASS (LBS) | PRESSURE CLASS (PSI) | DIAMETERS | CONNECTIONS/ ENDS | THREAD |
|--|------------|---|--------------|---|----------------------|----------------------|-----------------|--------------------|--------|
| 6 | BALL VALVE | 2-PIECE MONOBLOCK | SF02 | REDUCED BORE | 600-800 1500 | 1500 3000 | FROM 1/2" TO 4" | NPT BSP BSPT | F/F |
| MATERIAL | | SEATS | | SPECIAL EXECUTIONS | | | | | |
| STAINLESS STEEL 316 STAINLESS STEEL 304 STEEL LF2 STEEL A105 STEEL A105 N STEEL F51 BRONZE BRONZE-ALUMINIUM MONEL400 | | PTFE PTFE +GLASS PTFE + CARBONGRAPHITE DELRIN PEEK KEL-F DEVLON | | STAINLESS STEEL LEVERS AND BOLTS STEM EXTENSION PADLOCKING DEVICES OVAL HANDWHEELS CONSTRUCTION FOR ACTUATOR OPERATION SEAL WELDING FULLY WELDING COMBINED CONNECTIONS (EX.BSP/F/SW) DEGREASING FOR OXYGEN USE TAILOR-MADE LENGTH PERSONALIZED MARKING SINGLE PRODUCT PACKAGING SEATS AND GASKETS ON SPECIFIC REQUEST | | | | | |
|  | | | | | | | | | |



TEVAL
TECHNICAL VALVES

BALL VALVES

| POS/PG | TYPE | CLASSIFICATION | DRAWING CODE | FLUID PASSAGE SPECIFICATION | PRESSURE CLASS (LBS) | PRESSURE CLASS (PSI) | DIAMETERS | CONNECTIONS/ ENDS | THREAD |
|--|------------|--|--------------|--|----------------------|----------------------|-----------------|---------------------|--------|
| 7 | BALL VALVE | 2-PIECE MONOBLOCK | SF02/MF | REDUCED BORE | 600-800 1500 | 1500 3000 | FROM 1/2" TO 4" | NPT BSPP BSPT | M/F |
| MATERIAL | | SEATS | | SPECIAL EXECUTIONS | | | | | |
| STAINLESS STEEL 316 STAINLESS STEEL 304 STEEL LF2 STEEL A105 STEEL A105 N STEEL F51 BRONZE BRONZE-ALUMINIUM MONEL400 | | PTFE PTFE+GLASS PTFE + CARBONGRAPHITE PEEK KEL-F DEVLON DELRIN | | STAINLESS STEEL LEVERS AND BOLTS STEM EXTENSION PADLOCKING DEVICES OVAL HANDWHEELS CONSTRUCTION FOR ACTUATOR OPERATION SEAL WELDING FULLY WELDING COMBINED CONNECTIONS (EX.BSP- M/SW) DEGREASING FOR OXYGEN USE TAILOR-MADE LENGTH PERSONALIZED MARKING SINGLE PRODUCT PACKAGING SEATS AND GASKETS ON SPECIFIC REQUEST | | | | | |
|  | | | | | | | | | |

| POS/PG | TYPE | CLASSIFICATION | DRAWING CODE | FLUID PASSAGE SPECIFICATION | PRESSURE CLASS (LBS) | PRESSURE CLASS (PSI) | DIAMETERS | CONNECTIONS/ ENDS | THREAD |
|--|------------|--|--------------|---|----------------------|----------------------|-----------------|---------------------|--------|
| 8 | BALL VALVE | 3-PIECE MONOBLOCK | SF02/M2T | REDUCED BORE | 600-800 1500 | 1500 3000 | FROM 1/2" TO 4" | NPT BSPP BSPT | M/M |
| MATERIAL | | SEATS | | SPECIAL EXECUTIONS | | | | | |
| STAINLESS STEEL 316 STAINLESS STEEL 304 STEEL LF2 STEEL A105 STEEL A105 N STEEL F51 BRONZE BRONZE-ALUMINIUM MONEL400 | | PTFE PTFE+GLASS PTFE + CARBONGRAPHITE PEEK KEL-F DEVLON DELRIN | | STAINLESS STEEL LEVERS AND BOLTS STEM EXTENSION PADLOCKING DEVICES OVAL HANDWHEELS CONSTRUCTION FOR ACTUATOR OPERATION SEAL WELDING FULLY WELDING DEGREASING FOR OXYGEN USE TAILOR-MADE LENGTH PERSONALIZED MARKING SINGLE PRODUCT PACKAGING SEATS AND GASKETS ON SPECIFIC REQUEST | | | | | |
|  | | | | | | | | | |

| POS/PG | TYPE | CLASSIFICATION | DRAWING CODE | FLUID PASSAGE SPECIFICATION | PRESSURE CLASS (LBS) | PRESSURE CLASS (PSI) | DIAMETERS | CONNECTIONS/ ENDS | THREAD |
|---|------------|--|--------------|--|----------------------|----------------------|-----------------|-------------------|--------|
| 9 | BALL VALVE | 2-PIECE MONOBLOCK | SF02.SW | REDUCED BORE | 600-800 1500 | 1500 3000 | FROM 1/2" TO 4" | SW | - |
| MATERIAL | | SEATS | | SPECIAL EXECUTIONS | | | | | |
| STAINLESS STEEL 316 STAINLESS STEEL 304 STEEL LF2 STEEL A105 STEEL A105 N STEEL F51 BRONZE BRONZE-ALUMINIUM MONEL 400 | | PTFE PTFE+GLASS PTFE + CARBONGRAPHITE PEEK KEL-F DEVLON DELRIN | | STAINLESS STEEL LEVERS AND BOLTS STEM EXTENSION PADLOCKING DEVICES OVAL HANDWHEELS CONSTRUCTION FOR ACTUATOR OPERATION SEAL WELDING FULLY WELDING COMBINED CONNECTIONS (EX.BSP- F/SW) SCHEDULE VARIATION DEGREASING FOR OXYGEN USE TAILOR-MADE LENGTH PERSONALIZED MARKING SINGLE PRODUCT PACKAGING SEATS AND GASKETS ON SPECIFIC REQUEST | | | | | |
|  | | | | | | | | | |



BALL VALVES

| POS/PG | TYPE | CLASSIFICATION | DRAWING CODE | FLUID PASSAGE SPECIFICATION | PRESSURE CLASS (LBS) | PRESSURE CLASS (PSI) | DIAMETERS | CONNECTIONS/ ENDS | THREAD |
|---|------------|---|--------------|---|----------------------|----------------------|-----------------|-------------------|--------|
| 10 | BALL VALVE | 2-PIECE MONOBLOCK | SF04 | REDUCED BORE | 600-800 1500 | 1500 3000 | FROM 1/2" TO 4" | BW | - |
| MATERIAL | | SEATS | | SPECIAL EXECUTIONS | | | | | |
| STAINLESS STEEL 316 STAINLESS STEEL 304 STEEL LF2 STEEL A105 STEEL A105 N STEEL F51 BRONZE ALUMINIUM-BRONZE MONEL 400 | | PTFE PTFE +GLASS PTFE + CARBONGRAPHITE DELRIN PEEK KEL-F DEVLON | | STAINLESS STEEL LEVERS AND BOLTS STEM EXTENSION PADLOCKING DEVICES OVAL HANDWHEELS CONSTRUCTION FOR ACTUATOR OPERATION SEAL WELDING FULLY WELDING COMBINED CONNECTIONS (EX.BSP- F/B W) SCHEDULE VARIATION DEGREASING FOR OXYGEN USE TAILOR-MADE LENGTH PERSONALIZED MARKING SINGLE PRODUCT PACKAGING SEATS AND GASKETS ON SPECIFIC REQUEST | | | | | |
|  | | | | | | | | | |

| POS/PG | TYPE | CLASSIFICATION | DRAWING CODE | FLUID PASSAGE SPECIFICATION | PRESSURE CLASS (LBS) | PRESSURE CLASS (PSI) | DIAMETERS | CONNECTIONS/ ENDS | THREAD |
|--|------------|-----------------------------------|--------------|---|----------------------|----------------------|-----------------|---------------------|--------|
| 11 | BALL VALVE | 2-PIECE MONOBLOCK | SF01.6000 | OVERSIZE FULL BORE | 2500 | 6000 | FROM 1/4" TO 1" | NPT BSPP BSPT | F/F |
| MATERIAL | | SEATS | | SPECIAL EXECUTIONS | | | | | |
| STAINLESS STEEL 316 STAINLESS STEEL 304 STEEL LF2 STEEL A105 STEEL A105 N STEEL F51 BRONZE ALUMINIUM-BRONZE MONEL400 | | DELRIN PEEK KEL-F DEVLON | | STAINLESS STEEL LEVERS AND BOLTS STEM EXTENSION PADLOCKING DEVICES OVAL HANDWHEELS CONSTRUCTION FOR ACTUATOR OPERATION SEAL WELDING FULLY WELDING COMBINED CONNECTIONS (EX.BSP- F/SW) DEGREASING FOR OXYGEN USE TAILOR-MADE LENGTH PERSONALIZED MARKING SINGLE PRODUCT PACKAGING 1/8" DIAMETER REALIZATION SEATS AND GASKETS ON SPECIFIC REQUEST | | | | | |
|  | | | | | | | | | |

| POS/PG | TYPE | CLASSIFICATION | DRAWING CODE | FLUID PASSAGE SPECIFICATION | PRESSURE SERIES (LBS) | PRESSURE SERIES (PSI) | DIAMETERS | ATTACHMENTS/ ENDS | THREAD |
|--|------------|-----------------------------------|--------------|--|-----------------------|-----------------------|-----------------|---------------------|--------|
| 12 | BALL VALVE | 2-PIECE MONOBLOCK | SF01/MF.6000 | OVERSIZE FULL BORE | 2500 | 6000 | FROM 1/4" TO 1" | NPT BSPP BSPT | M/F |
| MATERIAL | | SEATS | | SPECIAL EXECUTIONS | | | | | |
| STAINLESS STEEL 316 STAINLESS STEEL 304 STEEL LF2 STEEL A105 STEEL A105 N STEEL F51 BRONZE ALUMINIUM-BRONZE MONEL400 | | DELRIN PEEK KEL-F DEVLON | | STAINLESS STEEL LEVERS AND BOLTS STEM EXTENSION PADLOCKING DEVICES OVAL HANDWHEELS CONSTRUCTION FOR ACTUATOR OPERATION SEAL WELDING FULLY WELDING COMBINED CONNECTIONS (EX.BSP- M/SW) DEGREASING FOR OXY GEN USE TAILOR-MADE LENGTH PERSONALIZED MARKING SINGLE PRODUCT PACKAGING 1/8" DIAMETER REALIZATION SEATS AND GASKETS ON SPECIFIC REQUEST | | | | | |
|  | | | | | | | | | |



TEVAL
TECHNICAL VALVES

BALL VALVES

| POS/PG | TYPE | CLASSIFICATION | DRAWING CODE | FLUID PASSAGE SPECIFICATION | PRESSURE CLASS (LBS) | PRESSURE CLASS (PSI) | DIAMETERS | CONNECTIONS/ ENDS | THREAD |
|---|------------|-----------------------------------|---------------|--|----------------------|----------------------|-----------------|---------------------|--------|
| 13 | BALL VALVE | 3-PIECE MONOBLOCK | SF01/MZT.6000 | OVERSIZE FULL BORE | 2500 | 6000 | FROM 1/4" TO 1" | NPT BSPP BSPT | M/M |
| MATERIAL | | SEATS | | SPECIAL EXECUTIONS | | | | | |
| STAINLESS STEEL 316 STAINLESS STEEL 304 STEEL LF2 STEEL A105 STEEL A105 N STEEL F51 BRONZE ALUMINIUM-BRONZE MONEL 400 | | PEEK KEL-F DEVLON DELRIN | | STAINLESS STEEL LEVERS AND BOLTS STEM EXTENSION PADLOCKING DEVICES OVAL HANDWHEELS CONSTRUCTION FOR ACTUATOR OPERATION SEAL WELDING FULLY WELDING DEGREASING FOR OXYGEN USE TAILOR-MADE LENGTH PERSONALIZED MARKING SINGLE PRODUCT PACKAGING 1/8" DIAMETER REALIZATION SEATS AND GASKETS ON SPECIFIC REQUEST | | | | | |



| POS/PG | TYPE | CLASSIFICATION | DRAWING CODE | FLUID PASSAGE SPECIFICATION | PRESSURE CLASS (LBS) | PRESSURE CLASS (PSI) | DIAMETERS | CONNECTIONS/ ENDS | THREAD |
|---|------------|-----------------------------------|--------------|---|----------------------|----------------------|-----------------|-------------------|--------|
| 14 | BALL VALVE | 2-PIECE MONOBLOCK | SF01.SW.6000 | OVERSIZE FULL BORE | 2500 | 6000 | FROM 1/4" TO 1" | SW | - |
| MATERIAL | | SEATS | | SPECIAL EXECUTIONS | | | | | |
| STAINLESS STEEL 316 STAINLESS STEEL 304 STEEL LF2 STEEL A105 STEEL A105 N STEEL F51 BRONZE ALUMINIUM-BRONZE MONEL 400 | | PEEK KEL-F DEVLON DELRIN | | STAINLESS STEEL LEVERS AND BOLTS STEM EXTENSION PADLOCKING DEVICES OVAL HANDWHEELS CONSTRUCTION FOR ACTUATOR OPERATION SEAL WELDING FULLY WELDING COMBINED CONNECTIONS (EX.BSP- F/SW) SCHEDULE VARIATION DEGREASING FOR OXYGEN USE TAILOR-MADE LENGTH PERSONALIZED MARKING SINGLE PRODUCT PACKAGING 1/8" DIAMETER REALIZATION SEATS AND GASKETS ON SPECIFIC REQUEST | | | | | |





| POS/PG | TYPE | CLASSIFICATION | DRAWING CODE | FLUID PASSAGE SPECIFICATION | PRESSURE CLASS (LBS) | PRESSURE CLASS (PSI) | DIAMETERS | CONNECTIONS/ ENDS | THREAD |
|---|------------|-----------------------------------|--------------|---|----------------------|----------------------|-----------------|-------------------|--------|
| 15 | BALL VALVE | 2-PIECE MONOBLOCK | SF03.6000 | OVERSIZE FULL BORE | 2500 | 6000 | FROM 1/4" TO 1" | BW | - |
| MATERIAL | | SEATS | | SPECIAL EXECUTIONS | | | | | |
| STAINLESS STEEL 316 STAINLESS STEEL 304 STEEL LF2 STEEL A105 STEEL A105 N STEEL F51 BRONZE ALUMINIUM-BRONZE MONEL 400 | | PEEK KEL-F DEVLON DELRIN | | STAINLESS STEEL LEVERS AND BOLTS STEM EXTENSION PADLOCKING DEVICES OVAL HANDWHEELS CONSTRUCTION FOR ACTUATOR OPERATION SEAL WELDING FULLY WELDING COMBINED CONNECTIONS (EX.BSP- F/BW) SCHEDULE VARIATION DEGREASING FOR OXYGEN USE TAILOR-MADE LENGTH PERSONALIZED MARKING SINGLE PRODUCT PACKAGING 1/8" DIAMETER REALIZATION SEATS AND GASKETS ON SPECIFIC REQUEST | | | | | |





BALL VALVES

| POS/PG | TYPE | CLASSIFICATION | DRAWING CODE | FLUID PASSAGE SPECIFICATION | PRESSURE CLASS (LBS) | PRESSURE CLASS (PSI) | DIAMETERS | CONNECTIONS/ ENDS | THREAD |
|---|------------|-----------------------------------|--------------|--|----------------------|----------------------|-----------------|---------------------|--------|
| 16 | BALL VALVE | 2-PIECE MONOBLOCK | SF02.6000 | OVERSIZE REDUCED BORE | 2500 | 6000 | FROM 1/2" TO 1" | NPT BSPP BSPT | F/F |
| MATERIAL | | SEATS | | SPECIAL EXECUTIONS | | | | | |
| STAINLESS STEEL 316 STAINLESS STEEL 304 STEEL LF2 STEEL A105 STEEL A105 N STEEL F51 BRONZE ALUMINIUM-BRONZE MONEL 400 | | DELRIN PEEK KEL-F DEVLON | | STAINLESS STEEL LEVERS AND BOLTS STEM EXTENSION PADLOCKING DEVICES OVAL HANDWHEELS CONSTRUCTION FOR ACTUATOR OPERATION SEAL WELDING FULLY WELDING COMBINED CONNECTIONS (EX.BSP- F/SW) DEGREASING FOR OXYGEN USE TAILOR-MADE LENGTH PERSONALIZED MARKING SINGLE PRODUCT PACKAGING SEATS AND GASKETS ON SPECIFIC REQUEST | | | | | |
|  | | | | | | | | | |

| POS/PG | TYPE | CLASSIFICATION | DRAWING CODE | FLUID PASSAGE SPECIFICATION | PRESSURE CLASS (LBS) | PRESSURE CLASS (PSI) | DIAMETERS | CONNECTIONS/ ENDS | THREAD |
|---|------------|-----------------------------------|--------------|--|----------------------|----------------------|-----------------|---------------------|--------|
| 17 | BALL VALVE | 2-PIECE MONOBLOCK | SF02/MF.6000 | OVERSIZE REDUCED BORE | 2500 | 6000 | FROM 1/2" TO 1" | NPT BSPP BSPT | M/F |
| MATERIAL | | SEATS | | SPECIAL EXECUTIONS | | | | | |
| STAINLESS STEEL 316 STAINLESS STEEL 304 STEEL LF2 STEEL A105 STEEL A105 N STEEL F51 BRONZE ALUMINIUM-BRONZE MONEL 400 | | DELRIN PEEK KEL-F DEVLON | | STAINLESS STEEL LEVERS AND BOLTS STEM EXTENSION PADLOCKING DEVICES OVAL HANDWHEELS CONSTRUCTION FOR ACTUATOR OPERATION SEAL WELDING FULLY WELDING COMBINED CONNECTIONS (EX.BSP- M/SW) DEGREASING FOR OXYGEN USE TAILOR-MADE LENGTH PERSONALIZED MARKING SINGLE PRODUCT PACKAGING SEATS AND GASKETS ON SPECIFIC REQUEST | | | | | |
|  | | | | | | | | | |

| POS/PG | TYPE | CLASSIFICATION | DRAWING CODE | FLUID PASSAGE SPECIFICATION | PRESSURE CLASS (LBS) | PRESSURE CLASS (PSI) | DIAMETERS | CONNECTIONS/ ENDS | THREAD |
|---|------------|-----------------------------------|---------------|---|----------------------|----------------------|-----------------|---------------------|--------|
| 18 | BALL VALVE | 3-PIECE MONOBLOCK | SF02/M2T.6000 | OVERSIZE REDUCED BORE | 2500 | 6000 | FROM 1/2" TO 1" | NPT BSPP BSPT | M/M |
| MATERIAL | | SEATS | | SPECIAL EXECUTIONS | | | | | |
| STAINLESS STEEL 316 STAINLESS STEEL 304 STEEL LF2 STEEL A105 STEEL A105 N STEEL F51 BRONZE ALUMINIUM-BRONZE MONEL 400 | | DELRIN PEEK KEL-F DEVLON | | STAINLESS STEEL LEVERS AND BOLTS STEM EXTENSION PADLOCKING DEVICES OVAL HANDWHEELS CONSTRUCTION FOR ACTUATOR OPERATION SEAL WELDING FULLY WELDING DEGREASING FOR OXYGEN USE TAILOR-MADE LENGTH PERSONALIZED MARKING SINGLE PRODUCT PACKAGING SEATS AND GASKETS ON SPECIFIC REQUEST | | | | | |
|  | | | | | | | | | |



TEVAL
TECHNICAL VALVES

BALL VALVES

| POS/PG | TYPE | CLASSIFICATION | DRAWING CODE | FLUID PASSAGE SPECIFICATION | PRESSURE CLASS (LBS) | PRESSURE CLASS (PSI) | DIAMETERS | CONNECTIONS/ ENDS | THREAD |
|---|-----------------------------------|--|--------------|-----------------------------|----------------------|----------------------|-----------------|-------------------|--------|
| 19 | BALL VALVE | 2-PIECE MONOBLOCK | SF02.SW.6000 | OVERSIZE REDUCED BORE | 2500 | 6000 | FROM 1/2" TO 1" | SW | - |
| MATERIAL | | SEATS | | SPECIAL EXECUTIONS | | | | | |
| STAINLESS STEEL 316 STAINLESS STEEL 304 STEEL LF2 STEEL A105 STEEL A105 N STEEL F51 BRONZE ALUMINIUM-BRONZE MONEL 400 | DELRIN PEEK KEL-F DEVLON | STAINLESS STEEL LEVERS AND BOLTS STEM EXTENSION PADLOCKING DEVICES OVAL HANDWHEELS CONSTRUCTION FOR ACTUATOR OPERATION SEAL WELDING FULLY WELDING COMBINED CONNECTIONS (EX.BSP- F/SW) SCHEDULE VARIATION DEGREASING FOR OXYGEN USE TAILOR-MADE LENGTH PERSONALIZED MARKING SINGLE PRODUCT PACKAGING SEATS AND GASKETS ON SPECIFIC REQUEST | | | | | | | |

| POS/PG | TYPE | CLASSIFICATION | DRAWING CODE | FLUID PASSAGE SPECIFICATION | PRESSURE CLASS (LBS) | PRESSURE CLASS (PSI) | DIAMETERS | CONNECTIONS/ ENDS | THREAD |
|---|-----------------------------------|--|--------------|-----------------------------|----------------------|----------------------|-----------------|-------------------|--------|
| 20 | BALL VALVE | 2-PIECE MONOBLOCK | SF04.6000 | OVERSIZE REDUCED BORE | 2500 | 6000 | FROM 1/2" TO 1" | BW | - |
| MATERIAL | | SEATS | | SPECIAL EXECUTIONS | | | | | |
| STAINLESS STEEL 316 STAINLESS STEEL 304 STEEL LF2 STEEL A105 STEEL A105 N STEEL F51 BRONZE ALUMINIUM-BRONZE MONEL 400 | DELRIN PEEK KEL-F DEVLON | STAINLESS STEEL LEVERS AND BOLTS STEM EXTENSION PADLOCKING DEVICES OVAL HANDWHEELS CONSTRUCTION FOR ACTUATOR OPERATION SEAL WELDING FULLY WELDING COMBINED CONNECTIONS (EX.BSP- M/SW) SCHEDULE VARIATION DEGREASING FOR OXYGEN USE TAILOR-MADE LENGTH PERSONALIZED MARKING SINGLE PRODUCT PACKAGING SEATS AND GASKETS ON SPECIFIC REQUEST | | | | | | | |

| POS/PG | TYPE | CLASSIFICATION | DRAWING CODE | FLUID PASSAGE SPECIFICATION | PRESSURE CLASS (LBS) | PRESSURE CLASS (PSI) | DIAMETERS | CONNECTIONS/ ENDS | THREAD |
|---|---|--|--------------|-----------------------------|----------------------|----------------------|-----------------|-------------------|--------|
| 21 | BALL VALVE | 3-PIECE MONOBLOCK | SF05 | FULL BORE | 600-800 1500 | 1500 3000 | FROM 1/4" TO 4" | SW | - |
| MATERIAL | | SEATS | | SPECIAL EXECUTIONS | | | | | |
| STAINLESS STEEL 316 STAINLESS STEEL 304 STEEL LF2 STEEL A105 STEEL A105 N STEEL F51 BRONZE ALUMINIUM-BRONZE MONEL 400 | PTFE PTFE +GLASS PTFE + CARBONGRAPHITE DELRIN PEEK KEL-F DEVLON | STAINLESS STEEL LEVERS AND BOLTS STEM EXTENSION PADLOCKING DEVICES OVAL HANDWHEELS CONSTRUCTION FOR ACTUATOR OPERATION SEAL WELDING FULLY WELDING COMBINED CONNECTIONS (EX.BSP- F/SW) SCHEDULE VARIATION DEGREASING FOR OXYGEN USE TAILOR-MADE LENGTH PERSONALIZED MARKING SINGLE PRODUCT PACKAGING SEATS AND GASKETS ON SPECIFIC REQUEST | | | | | | | |



BALL VALVES

| POS/PG | TYPE | CLASSIFICATION | DRAWING CODE | FLUID PASSAGE SPECIFICATION | PRESSURE CLASS (LBS) | PRESSURE CLASS (PSI) | DIAMETERS | CONNECTIONS/ ENDS | THREAD |
|--|------------|---|--------------|--|----------------------|----------------------|-----------------|-------------------|--------|
| 22 | BALL VALVE | 3-PIECE MONOBLOCK | SF06 | REDUCED BORE | 600-800 1500 | 1500 3000 | FROM 1/2" TO 4" | SW | |
| MATERIAL | | SEATS | | SPECIAL EXECUTIONS | | | | | |
| STAINLESS STEEL 316 STAINLESS STEEL 304 STEEL LF2 STEEL A105 STEEL A105 N STEEL F51 BRONZE ALUMINIUM-BRONZE MONEL400 | | PTFE PTFE +GLASS PTFE + CARBONGRAPHITE DELRIN PEEK KEL-F DEVLON | | STAINLESS STEEL LEVERS AND BOLTS STEM EXTENSION PADLOCKING DEVICES OVAL HANDWHEELS CONSTRUCTION FOR ACTUATOR OPERATION SEAL WELDING FULLY WELDING COMBINED CONNECTIONS (EX.BSP- F/SW) SCHEDULE VARIATION DEGREASING FOR OXYGEN USE TAILOR-MADE LENGTH PERSONALIZED MARKING SINGLE PRODUCT PACKAGING SEATS AND GASKETS ON SPECIFIC REQUEST | | | | | |
|  | | | | | | | | | |

| POS/PG | TYPE | CLASSIFICATION | DRAWING CODE | FLUID PASSAGE SPECIFICATION | PRESSURE CLASS (LBS) | PRESSURE CLASS (PSI) | DIAMETERS | CONNECTIONS/ ENDS | THREAD |
|--|------------|---|--------------|---|----------------------|----------------------|-----------------|-------------------|--------|
| 23 | BALL VALVE | 3-PIECE MONOBLOCK | SF07 | FULL BORE | 600-800 1500 | 1500 3000 | FROM 1/4" TO 4" | BW | |
| MATERIAL | | SEATS | | SPECIAL EXECUTIONS | | | | | |
| STAINLESS STEEL 316 STAINLESS STEEL 304 STEEL LF2 STEEL A105 STEEL A105 N STEEL F51 BRONZE ALUMINIUM-BRONZE MONEL400 | | PTFE PTFE +GLASS PTFE + CARBONGRAPHITE DELRIN PEEK KEL-F DEVLON | | STAINLESS STEEL LEVERS AND BOLTS STEM EXTENSION PADLOCKING DEVICES OVAL HANDWHEELS CONSTRUCTION FOR ACTUATOR OPERATION SEAL WELDING FULLY WELDING COMBINED CONNECTIONS (EX.BSP- F/BW) SCHEDULE VARIATION DEGREASING FOR OXYGEN USE TAILOR-MADE LENGTH PERSONALIZED MARKING SINGLE PRODUCT PACKAGING 1/8" DIAMETER REALIZATION SEATS AND GASKETS ON SPECIFIC REQUEST | | | | | |
|  | | | | | | | | | |

| POS/PG | TYPE | CLASSIFICATION | DRAWING CODE | FLUID PASSAGE SPECIFICATION | PRESSURE CLASS (LBS) | PRESSURE CLASS (PSI) | DIAMETERS | CONNECTIONS/ ENDS | THREAD |
|--|------------|---|--------------|--|----------------------|----------------------|-----------------|-------------------|--------|
| 24 | BALL VALVE | 3-PIECE MONOBLOCK | SF08 | REDUCED BORE | 600-800 1500 | 1500 3000 | FROM 1/2" TO 4" | BW | |
| MATERIAL | | SEATS | | SPECIAL EXECUTIONS | | | | | |
| STAINLESS STEEL 316 STAINLESS STEEL 304 STEEL LF2 STEEL A105 STEEL A105 N STEEL F51 BRONZE ALUMINIUM-BRONZE MONEL400 | | PTFE PTFE +GLASS PTFE + CARBONGRAPHITE DELRIN PEEK KEL-F DEVLON | | STAINLESS STEEL LEVERS AND BOLTS STEM EXTENSION PADLOCKING DEVICES OVAL HANDWHEELS CONSTRUCTION FOR ACTUATOR OPERATION SEAL WELDING FULLY WELDING COMBINED CONNECTIONS (EX.BSP- F/BW) SCHEDULE VARIATION DEGREASING FOR OXYGEN USE TAILOR-MADE LENGTH PERSONALIZED MARKING SINGLE PRODUCT PACKAGING SEATS AND GASKETS ON SPECIFIC REQUEST | | | | | |
|  | | | | | | | | | |



TEVAL
TECHNICAL VALVES

BALL VALVES

| POS/PG | TYPE | CLASSIFICATION | DRAWING CODE | FLUID PASSAGE SPECIFICATION | PRESSURE CLASS (LBS) | PRESSURE CLASS (PSI) | DIAMETERS | CONNECTIONS/ ENDS | THREAD |
|---|------------|---|--------------|---|----------------------|----------------------|--|-------------------|--------|
| 25 | BALL VALVE | 3-PIECE MONOBLOCK | SF07.PE | FULL BORE | 600-800 1500 | 1500 3000 | FROM 1/4" TO 4" | PE | - |
| MATERIAL | | SEATS | | SPECIAL EXECUTIONS | | |  | | |
| STAINLESS STEEL 316 STAINLESS STEEL 304 STEEL LF2 STEEL A105 STEEL A105 N STEEL F51 BRONZE ALUMINIUM-BRONZE MONEL 400 | | PTFE PTFE +GLASS PTFE + CARBONGRAPHITE DELRIN PEEK KEL-F DEVLON | | STAINLESS STEEL LEVERS AND BOLTS STEM EXTENSION PADLOCKING DEVICES OVAL HANDWHEELS CONSTRUCTION FOR ACTUATOR OPERATION SEAL WELDING FULLY WELDING COMBINED CONNECTIONS (EX.BSP- F/PE) SCHEDULE VARIATION DEGREASING FOR OXYGEN USE TAILOR-MADE LENGTH PERSONALIZED MARKING SINGLE PRODUCT PACKAGING 1/8" DIAMETER REALIZATION SEATS AND GASKETS ON SPECIFIC REQUEST | | | | | |

| POS/PG | TYPE | CLASSIFICATION | DRAWING CODE | FLUID PASSAGE SPECIFICATION | PRESSURE CLASS (LBS) | PRESSURE CLASS (PSI) | DIAMETERS | CONNECTIONS/ ENDS | THREAD |
|---|------------|---|--------------|--|----------------------|----------------------|--|-------------------|--------|
| 26 | BALL VALVE | 3-PIECE MONOBLOCK | SF08.PE | REDUCED BORE | 600-800 1500 | 1500 3000 | FROM 1/2" TO 4" | PE | - |
| MATERIAL | | SEATS | | SPECIAL EXECUTIONS | | |  | | |
| STAINLESS STEEL 316 STAINLESS STEEL 304 STEEL LF2 STEEL A105 STEEL A105 N STEEL F51 BRONZE ALUMINIUM-BRONZE MONEL 400 | | PTFE PTFE +GLASS PTFE + CARBONGRAPHITE DELRIN PEEK KEL-F DEVLON | | STAINLESS STEEL LEVERS AND BOLTS STEM EXTENSION PADLOCKING DEVICES OVAL HANDWHEELS CONSTRUCTION FOR ACTUATOR OPERATION SEAL WELDING FULLY WELDING COMBINED CONNECTIONS (EX.BSP- F/PE) SCHEDULE VARIATION DEGREASING FOR OXYGEN USE TAILOR-MADE LENGTH PERSONALIZED MARKING SINGLE PRODUCT PACKAGING SEATS AND GASKETS ON SPECIFIC REQUEST | | | | | |

| POS/PG | TYPE | CLASSIFICATION | DRAWING CODE | FLUID PASSAGE SPECIFICATION | PRESSURE CLASS (LBS) | PRESSURE CLASS (PSI) | DIAMETERS | CONNECTIONS/ ENDS | THREAD |
|---|------------|-----------------------------------|--------------|---|----------------------|----------------------|--|-------------------|--------|
| 27 | BALL VALVE | 3-PIECE MONOBLOCK | SF05.6000 | OVERSIZE FULL BORE | 2500 | 6000 | FROM 1/4" TO 1" | SW | - |
| MATERIAL | | SEATS | | SPECIAL EXECUTIONS | | |  | | |
| STAINLESS STEEL 316 STAINLESS STEEL 304 STEEL LF2 STEEL A105 STEEL A105 N STEEL F51 BRONZE ALUMINIUM-BRONZE MONEL 400 | | DELRIN PEEK KEL-F DEVLON | | STAINLESS STEEL LEVERS AND BOLTS STEM EXTENSION PADLOCKING DEVICES OVAL HANDWHEELS CONSTRUCTION FOR ACTUATOR OPERATION SEAL WELDING FULLY WELDING COMBINED CONNECTIONS (EX.BSP- F/SW) SCHEDULE VARIATION DEGREASING FOR OXYGEN USE TAILOR-MADE LENGTH PERSONALIZED MARKING SINGLE PRODUCT PACKAGING 1/8" DIAMETER REALIZATION SEATS AND GASKETS ON SPECIFIC REQUEST | | | | | |

BALL VALVES

| POS/PG | TYPE | CLASSIFICATION | DRAWING CODE | FLUID PASSAGE SPECIFICATION | PRESSURE CLASS (LBS) | PRESSURE CLASS (PSI) | DIAMETERS | CONNECTIONS/ ENDS | THREAD |
|---|------------|-----------------------------------|--------------|---|----------------------|----------------------|-----------------|-------------------|--------|
| 28 | BALL VALVE | 3-PIECE MONOBLOCK | SF07.6000 | OVERSIZE FULL BORE | 2500 | 6000 | FROM 1/4" TO 1" | BW | - |
| MATERIAL | | SEATS | | SPECIAL EXECUTIONS | | | | | |
| STAINLESS STEEL 316 STAINLESS STEEL 304 STEEL LF2 STEEL A105 STEEL A105 N STEEL F51 BRONZE ALUMINIUM-BRONZE MONEL 400 | | DELRIN PEEK KEL-F DEVLON | | STAINLESS STEEL LEVERS AND BOLTS STEM EXTENSION PADLOCKING DEVICES OVAL HANDWHEELS CONSTRUCTION FOR ACTUATOR OPERATION SEAL WELDING FULLY WELDING COMBINED CONNECTIONS (EX.BSP- F/BW) SCHEDULE VARIATION DEGREASING FOR OXYGEN USE TAILOR-MADE LENGTH PERSONALIZED MARKING SINGLE PRODUCT PACKAGING 1/8" DIAMETER REALIZATION SEATS AND GASKETS ON SPECIFIC REQUEST | | | | | |



| POS/PG | TYPE | CLASSIFICATION | DRAWING CODE | FLUID PASSAGE SPECIFICATION | PRESSURE CLASS (LBS) | PRESSURE CLASS (PSI) | DIAMETERS | CONNECTIONS/ ENDS | THREAD |
|---|------------|-----------------------------------|--------------|---|----------------------|----------------------|-----------------|-------------------|--------|
| 29 | BALL VALVE | 3-PIECE MONOBLOCK | SF07.PE.6000 | OVERSIZE FULL BORE | 2500 | 6000 | FROM 1/4" TO 1" | PE | - |
| MATERIAL | | SEATS | | SPECIAL EXECUTIONS | | | | | |
| STAINLESS STEEL 316 STAINLESS STEEL 304 STEEL LF2 STEEL A105 STEEL A105 N STEEL F51 BRONZE ALUMINIUM-BRONZE MONEL 400 | | DELRIN PEEK KEL-F DEVLON | | STAINLESS STEEL LEVERS AND BOLTS STEM EXTENSION PADLOCKING DEVICES OVAL HANDWHEELS CONSTRUCTION FOR ACTUATOR OPERATION SEAL WELDING FULLY WELDING COMBINED CONNECTIONS (EX.BSP- F/PE) SCHEDULE VARIATION DEGREASING FOR OXYGEN USE TAILOR-MADE LENGTH PERSONALIZED MARKING SINGLE PRODUCT PACKAGING 1/8" DIAMETER REALIZATION SEATS AND GASKETS ON SPECIFIC REQUEST | | | | | |





| POS/PG | TYPE | CLASSIFICATION | DRAWING CODE | FLUID PASSAGE SPECIFICATION | PRESSURE CLASS (LBS) | PRESSURE CLASS (PSI) | DIAMETERS | CONNECTIONS/ ENDS | THREAD |
|---|------------|-----------------------------------|--------------|--|----------------------|----------------------|-----------------|-------------------|--------|
| 30 | BALL VALVE | 3-PIECE MONOBLOCK | SF 06.6000 | OVERSIZE REDUCED BORE | 2500 | 6000 | FROM 1/2" TO 1" | SW | - |
| MATERIAL | | SEATS | | SPECIAL EXECUTIONS | | | | | |
| STAINLESS STEEL 316 STAINLESS STEEL 304 STEEL LF2 STEEL A105 STEEL A105 N STEEL F51 BRONZE ALUMINIUM-BRONZE MONEL 400 | | DELRIN PEEK KEL-F DEVLON | | STAINLESS STEEL LEVERS AND BOLTS STEM EXTENSION PADLOCKING DEVICES OVAL HANDWHEELS CONSTRUCTION FOR ACTUATOR OPERATION SEAL WELDING FULLY WELDING COMBINED CONNECTIONS (EX.BSP- F/SW) SCHEDULE VARIATION DEGREASING FOR OXYGEN USE TAILOR-MADE LENGTH PERSONALIZED MARKING SINGLE PRODUCT PACKAGING SEATS AND GASKETS ON SPECIFIC REQUEST | | | | | |





BALL VALVES

| POS/PG | TYPE | CLASSIFICATION | DRAWING CODE | FLUID PASSAGE SPECIFICATION | PRESSURE CLASS (LBS) | PRESSURE CLASS (PSI) | DIAMETERS | CONNECTIONS/ ENDS | THREAD |
|---|------------|-----------------------------------|--------------|--|----------------------|--|-----------------|-------------------|--------|
| 31 | BALL VALVE | 3-PIECE MONOBLOCK | SF08.6000 | OVERSIZE REDUCED BORE | 2500 | 6000 | FROM 1/2" TO 1" | BW | - |
| MATERIAL | | SEATS | | SPECIAL EXECUTIONS | |  | | | |
| STAINLESS STEEL 316 STAINLESS STEEL 304 STEEL LF2 STEEL A105 STEEL A105 N STEEL F51 BRONZE ALUMINIUM-BRONZE MONEL 400 | | DELRIN PEEK KEL-F DEVLON | | STAINLESS STEEL LEVERS AND BOLTS STEM EXTENSION PADLOCKING DEVICES OVAL HANDWHEELS CONSTRUCTION FOR ACTUATOR OPERATION SEAL WELDING FULLY WELDING COMBINED CONNECTIONS (EX.BSP- F/BW) SCHEDULE VARIATION DEGREASING FOR OXYGEN USE TAILOR-MADE LENGTH PERSONALIZED MARKING SINGLE PRODUCT PACKAGING SEATS AND GASKETS ON SPECIFIC REQUEST | | | | | |

| POS/PG | TYPE | CLASSIFICATION | DRAWING CODE | FLUID PASSAGE SPECIFICATION | PRESSURE CLASS (LBS) | PRESSURE CLASS (PSI) | DIAMETERS | CONNECTIONS/ ENDS | THREAD |
|---|------------|-----------------------------------|--------------|--|----------------------|--|-----------------|-------------------|--------|
| 32 | BALL VALVE | 3-PIECE MONOBLOCK | SF08.PE.6000 | OVERSIZE REDUCED BORE | 2500 | 6000 | FROM 1/2" TO 1" | PE | - |
| MATERIAL | | SEATS | | SPECIAL EXECUTIONS | |  | | | |
| STAINLESS STEEL 316 STAINLESS STEEL 304 STEEL LF2 STEEL A105 STEEL A105 N STEEL F51 BRONZE ALUMINIUM-BRONZE MONEL 400 | | DELRIN PEEK KEL-F DEVLON | | STAINLESS STEEL LEVERS AND BOLTS STEM EXTENSION PADLOCKING DEVICES OVAL HANDWHEELS CONSTRUCTION FOR ACTUATOR OPERATION SEAL WELDING FULLY WELDING COMBINED CONNECTIONS (EX.BSP- F/PE) SCHEDULE VARIATION DEGREASING FOR OXYGEN USE TAILOR-MADE LENGTH PERSONALIZED MARKING SINGLE PRODUCT PACKAGING SEATS AND GASKETS ON SPECIFIC REQUEST | | | | | |

| POS/PG | TYPE | CLASSIFICATION | DRAWING CODE | FLUID PASSAGE SPECIFICATION | PRESSURE CLASS (LBS) | PRESSURE CLASS (PSI) | DIAMETERS | CONNECTIONS/ ENDS | THREAD |
|---|------------|---|--------------|---|----------------------|--|-----------------|-------------------|--------|
| 33 | BALL VALVE | 3-PIECE MONOBLOCK | SF12 | FULL BORE | PN 10/16 PN 40 | - | FROM 1/4" TO 4" | FLANGED | - |
| MATERIAL | | SEATS | | SPECIAL EXECUTIONS | |  | | | |
| STAINLESS STEEL 316 STAINLESS STEEL 304 STEEL LF2 STEEL A105 STEEL A105 N STEEL F51 BRONZE ALUMINIUM-BRONZE MONEL 400 | | PTFE PTFE +GLASS PTFE + CARBONGRAPHITE DELRIN PEEK KEL-F DEVLON | | STAINLESS STEEL LEVERS AND BOLTS STEM EXTENSION PADLOCKING DEVICES OVAL HANDWHEELS CONSTRUCTION FOR ACTUATOR OPERATION THREADED OR WELDED FLANGES DEGREASING FOR OXYGEN USE TAILOR-MADE LENGTH PERSONALIZED MARKING SINGLE PRODUCT PACKAGING 1/8" DIAMETER REALIZATION SEATS AND GASKETS ON SPECIFIC REQUEST | | | | | |



BALL VALVES

| POS/PG | TYPE | CLASSIFICATION | DRAWING CODE | FLUID PASSAGE SPECIFICATION | PRESSURE CLASS (LBS) | PRESSURE CLASS (PSI) | DIAMETERS | CONNECTIONS/ ENDS | THREAD |
|---|------------|---|--------------|---|----------------------|----------------------|-----------------|-------------------|--------|
| 34 | BALL VALVE | 3-PIECE MONOBLOCK | SF12.300 | FULL BORE | ANSI 150 ANSI 300 | - | FROM 1/4" TO 4" | FLANGED | - |
| MATERIAL | | SEATS | | SPECIAL EXECUTIONS | | | | | |
| STAINLESS STEEL 316 STAINLESS STEEL 304 STEEL LF2 STEEL A105 STEEL A105 N STEEL F51 BRONZE ALUMINIUM-BRONZE MONEL 400 | | PTFE PTFE +GLASS PTFE + CARBONGRAPHITE DELRIN PEEK KEL-F DEVLON | | STAINLESS STEEL LEVERS AND BOLTS STEM EXTENSION PADLOCKING DEVICES OVAL HANDWHEELS CONSTRUCTION FOR ACTUATOR OPERATION THREADED OR WELDED FLANGES DEGREASING FOR OXYGEN USE TAILOR-MADE LENGTH PERSONALIZED MARKING SINGLE PRODUCT PACKAGING 1/8" DIAMETER REALIZATION SEATS AND GASKETS ON SPECIFIC REQUEST | | | | | |
| | | | | | | | | | |

| POS/PG | TYPE | CLASSIFICATION | DRAWING CODE | FLUID PASSAGE SPECIFICATION | PRESSURE CLASS (LBS) | PRESSURE CLASS (PSI) | DIAMETERS | CONNECTIONS/ ENDS | THREAD |
|---|------------|---|--------------|---|----------------------|----------------------|-----------------|-------------------|--------|
| 35 | BALL VALVE | 3-PIECE MONOBLOCK | SF12.600 | FULL BORE | ANSI 600 | - | FROM 1/4" TO 1" | FLANGED | - |
| MATERIAL | | SEATS | | SPECIAL EXECUTIONS | | | | | |
| STAINLESS STEEL 316 STAINLESS STEEL 304 STEEL LF2 STEEL A105 STEEL A105 N STEEL F51 BRONZE ALUMINIUM-BRONZE MONEL 400 | | PTFE PTFE +GLASS PTFE + CARBONGRAPHITE DELRIN PEEK KEL-F DEVLON | | STAINLESS STEEL LEVERS AND BOLTS STEM EXTENSION PADLOCKING DEVICES OVAL HANDWHEELS CONSTRUCTION FOR ACTUATOR OPERATION THREADED OR WELDED FLANGES DEGREASING FOR OXYGEN USE TAILOR-MADE LENGTH PERSONALIZED MARKING SINGLE PRODUCT PACKAGING 1/8" DIAMETER REALIZATION SEATS AND GASKETS ON SPECIFIC REQUEST | | | | | |
| | | | | | | | | | |

| POS/PG | TYPE | CLASSIFICATION | DRAWING CODE | FLUID PASSAGE SPECIFICATION | PRESSURE CLASS (LBS) | PRESSURE CLASS (PSI) | DIAMETERS | CONNECTIONS/ ENDS | THREAD |
|---|------------|---|--------------|--|----------------------|----------------------|-----------------|-------------------|--------|
| 36 | BALL VALVE | 3-PIECE MONOBLOCK | SF12 | REDUCED BORE | PN 10/16 PN 40 | - | FROM 1/2" TO 4" | FLANGED | - |
| MATERIAL | | SEATS | | SPECIAL EXECUTIONS | | | | | |
| STAINLESS STEEL 316 STAINLESS STEEL 304 STEEL LF2 STEEL A105 STEEL A105 N STEEL F51 BRONZE ALUMINIUM-BRONZE MONEL 400 | | PTFE PTFE +GLASS PTFE + CARBONGRAPHITE DELRIN PEEK KEL-F DEVLON | | STAINLESS STEEL LEVERS AND BOLTS STEM EXTENSION PADLOCKING DEVICES OVAL HANDWHEELS CONSTRUCTION FOR ACTUATOR OPERATION THREADED OR WELDED FLANGES DEGREASING FOR OXYGEN USE TAILOR-MADE LENGTH PERSONALIZED MARKING SINGLE PRODUCT PACKAGING SEATS AND GASKETS ON SPECIFIC REQUEST | | | | | |
| | | | | | | | | | |



TEVAL
TECHNICAL VALVES

BALL VALVES

| POS/PG | TYPE | CLASSIFICATION | DRAWING CODE | FLUID PASSAGE SPECIFICATION | PRESSURE CLASS (LBS) | PRESSURE CLASS (PSI) | DIAMETERS | CONNECTIONS/ ENDS | THREAD |
|---|------------|--|--------------|--|----------------------|--|-----------------|-------------------|--------|
| 37 | BALL VALVE | 3-PIECE MONOBLOCK | SF12.300 | REDUCED BORE | ANSI 150 ANSI 300 | - | FROM 1/2" TO 4" | FLANGED | - |
| MATERIAL | | SEATS | | SPECIAL EXECUTIONS | |  | | | |
| STAINLESS STEEL 316 STAINLESS STEEL 304 STEEL LF2 STEEL A105 STEEL A105 N STEEL F51 BRONZE ALUMINIUM-BRONZE MONEL 400 | | PTFE PTFE+GLASS PTFE + CARBONGRAPHITE DELRIN PEEK KEL-F DEVLON | | STAINLESS STEEL LEVERS AND BOLTS STEM EXTENSION PADLOCKING DEVICES OVAL HANDWHEELS CONSTRUCTION FOR ACTUATOR OPERATION THREADED OR WELDED FLANGES DEGREASING FOR OXYGEN USE TAILOR-MADE LENGTH PERSONALIZED MARKING SINGLE PRODUCT PACKAGING SEATS AND GASKETS ON SPECIFIC REQUEST | | | | | |

| POS/PG | TYPE | CLASSIFICATION | DRAWING CODE | FLUID PASSAGE SPECIFICATION | PRESSURE CLASS (LBS) | PRESSURE CLASS (PSI) | DIAMETERS | CONNECTIONS/ ENDS | THREAD |
|---|------------|--|--------------|--|----------------------|--|-----------------|-------------------|--------|
| 38 | BALL VALVE | 3-PIECE MONOBLOCK | SF12.600 | REDUCED BORE | ANSI 600 | - | FROM 1/2" TO 4" | FLANGED | - |
| MATERIAL | | SEATS | | SPECIAL EXECUTIONS | |  | | | |
| STAINLESS STEEL 316 STAINLESS STEEL 304 STEEL LF2 STEEL A105 STEEL A105 N STEEL F51 BRONZE ALUMINIUM-BRONZE MONEL 400 | | PTFE PTFE+GLASS PTFE + CARBONGRAPHITE DELRIN PEEK KEL-F DEVLON | | STAINLESS STEEL LEVERS AND BOLTS STEM EXTENSION PADLOCKING DEVICES OVAL HANDWHEELS CONSTRUCTION FOR ACTUATOR OPERATION THREADED OR WELDED FLANGES DEGREASING FOR OXYGEN USE TAILOR-MADE LENGTH PERSONALIZED MARKING SINGLE PRODUCT PACKAGING SEATS AND GASKETS ON SPECIFIC REQUEST | | | | | |

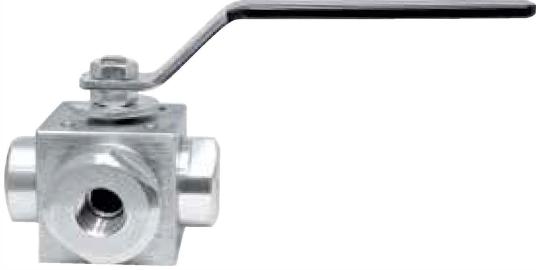
| POS/PG | TYPE | CLASSIFICATION | DRAWING CODE | FLUID PASSAGE SPECIFICATION | PRESSURE CLASS (LBS) | PRESSURE CLASS (PSI) | DIAMETERS | CONNECTIONS/ ENDS | THREAD |
|-----------------------------------|------------|--|--------------|--|----------------------|--|----------------------|---------------------|--------|
| 39 | BALL VALVE | "T"/"L" PORT 3-WAY MONOBLOCK | SF10 | FULL BORE | 600-800 1500 | 1500 3000 | FROM 1/4" TO 1" 1/2" | NPT BSPP BSPT | F/F |
| MATERIAL | | SEATS | | SPECIAL EXECUTIONS | |  | | | |
| STAINLESS STEEL 316 STEEL A105 | | PTFE PTFE+GLASS PTFE + CARBONGRAPHITE DELRIN PEEK KEL-F DEVLON | | STAINLESS STEEL LEVERS AND BOLTS STEM EXTENSION PADLOCKING DEVICES OVAL HANDWHEELS CONSTRUCTION FOR ACTUATOR OPERATION SEAL WELDING FULLY WELDING COMBINED CONNECTIONS (EX.BSP- F/SW) DEGREASING FOR OXYGEN USE TAILOR-MADE LENGTH PERSONALIZED MARKING SINGLE PRODUCT PACKAGING 1/8" DIAMETER REALIZATION SEATS AND GASKETS ON SPECIFIC REQUEST M/F THREADS COMBINATION | | | | | |



TEVAL
TECHNICAL VALVES

BALL VALVES

| POS/PG | TYPE | CLASSIFICATION | DRAWING CODE | FLUID PASSAGE SPECIFICATION | PRESSURE CLASS (LBS) | PRESSURE CLASS (PSI) | DIAMETERS | CONNECTIONS/ ENDS | THREAD |
|-----------------------------------|------------|---|--------------|--|----------------------|----------------------|---------------------|-------------------|--------|
| 40 | BALL VALVE | "T"/"L" PORT 3-WAY MONOBLOCK | SF10 | FULL BORE | 600-800 1500 | 1500 3000 | FROM 1/4" TO 1 1/2" | SW | - |
| MATERIAL | | SEATS | | SPECIAL EXECUTIONS | | | | | |
| STAINLESS STEEL 316 STEEL A105 | | PTFE PTFE + GLASS PTFE + CARBONGRAPHITE DELTRIN PEEK KEL-F DEVLON | | STAINLESS STEEL LEVERS AND BOLTS STEM EXTENSION PADLOCKING DEVICES OVAL HANDWHEELS CONSTRUCTION FOR ACTUATOR OPERATION SEAL WELDING FULLY WELDING COMBINED CONNECTIONS (EX.BSP- F/SW) DEGREASING FOR OXYGEN USE TAILOR-MADE LENGTH ALTERNATIVE BW AND WITH NIPPLES PERSONALIZED MARKING SINGLE PRODUCT PACKAGING 1/8" DIAMETER REALIZATION SEATS AND GASKETS ON SPECIFIC REQUEST | | | | | |
| | | | | | | | | | |

| POS/PG | TYPE | CLASSIFICATION | DRAWING CODE | FLUID PASSAGE SPECIFICATION | PRESSURE CLASS (LBS) | PRESSURE CLASS (PSI) | DIAMETERS | CONNECTIONS/ ENDS | THREAD |
|-----------------------------------|------------|---|--------------|---|----------------------|----------------------|-----------------|---------------------|--------|
| 41 | BALL VALVE | "T"/"L" PORT 3-WAY MONOBLOCK | SF11 | REDUCED BORE | 600-800 1500 | 1500 3000 | FROM 1/2" TO 2" | NPT BSPP BSPT | F/F |
| MATERIAL | | SEATS | | SPECIAL EXECUTIONS | | | | | |
| STAINLESS STEEL 316 STEEL A105 | | PTFE PTFE + GLASS PTFE + CARBONGRAPHITE DELTRIN PEEK KEL-F DEVLON | | STAINLESS STEEL LEVERS AND BOLTS STEM EXTENSION PADLOCKING DEVICES OVAL HANDWHEELS CONSTRUCTION FOR ACTUATOR OPERATION SEAL WELDING FULLY WELDING COMBINED CONNECTIONS (EX.BSP- F/SW) DEGREASING FOR OXYGEN USE TAILOR-MADE LENGTH PERSONALIZED MARKING SINGLE PRODUCT PACKAGING SEATS AND GASKETS ON SPECIFIC REQUEST M/F THREADS COMBINATION | | | | | |
| | | | | | | | | | |

| POS/PG | TYPE | CLASSIFICATION | DRAWING CODE | FLUID PASSAGE SPECIFICATION | PRESSURE CLASS (LBS) | PRESSURE CLASS (PSI) | DIAMETERS | CONNECTIONS/ ENDS | THREAD |
|-----------------------------------|------------|---|--------------|---|----------------------|----------------------|-----------------|-------------------|--------|
| 42 | BALL VALVE | "T"/"L" PORT 3-WAY MONOBLOCK | SF11 | REDUCED BORE | 600-800 1500 | 1500 3000 | FROM 1/2" TO 2" | SW | - |
| MATERIAL | | SEATS | | SPECIAL EXECUTIONS | | | | | |
| STAINLESS STEEL 316 STEEL A105 | | PTFE PTFE + GLASS PTFE + CARBONGRAPHITE DELTRIN PEEK KEL-F DEVLON | | STAINLESS STEEL LEVERS AND BOLTS STEM EXTENSION PADLOCKING DEVICES OVAL HANDWHEELS CONSTRUCTION FOR ACTUATOR OPERATION SEAL WELDING FULLY WELDING COMBINED CONNECTIONS (EX.BSP- F/SW) DEGREASING FOR OXYGEN USE TAILOR-MADE LENGTH ALTERNATIVE BW AND WITH NIPPLES PERSONALIZED MARKING SINGLE PRODUCT PACKAGING SEATS AND GASKETS ON SPECIFIC REQUEST | | | | | |
| | | | | | | | | | |



BALL VALVES

| POS/PG | TYPE | CLASSIFICATION | DRAWING CODE | FLUID PASSAGE SPECIFICATION | PRESSURE CLASS (LBS) | PRESSURE CLASS (PSI) | DIAMETERS | CONNECTIONS/ ENDS | THREAD |
|-----------------------------------|------------|---|--------------|---|--|----------------------|---------------------|-------------------|--------|
| 43 | BALL VALVE | "T"/"L" PORT 3-WAY MONOBLOCK | SF14 | FULL BORE | PN 16 PN25/40 ANSI 150 ANSI 300 | - | FROM 1/4" TO 1" 1/2 | FLANGED | - |
| MATERIAL | | SEATS | | SPECIAL EXECUTIONS | | | | | |
| STAINLESS STEEL 316 STEEL A105 | | PTFE PTFE+GLASS PTFE + CARBONGRAPHITE DELTRIN PEEK KEL-F DEVLON | | STAINLESS STEEL LEVERS AND BOLTS STEM EXTENSION PADLOCKING DEVICES OVAL HANDWHEELS CONSTRUCTION FOR ACTUATOR OPERATION SEAL WELDING FULLY WELDING COMBINED CONNECTIONS (EX.BSP- F/SW) DEGREASING FOR OXYGEN USE TAILOR-MADE LENGTH PERSONALIZED MARKING SINGLE PRODUCT PACKAGING 1/8" DIAMETER REALIZATION SEATS AND GASKETS ON SPECIFIC REQUEST | | | | | |
| | | | | | | | | | |

| POS/PG | TYPE | CLASSIFICATION | DRAWING CODE | FLUID PASSAGE SPECIFICATION | PRESSURE CLASS (LBS) | PRESSURE CLASS (PSI) | DIAMETERS | CONNECTIONS/ ENDS | THREAD |
|-----------------------------------|------------|---|--------------|---|---|----------------------|-----------------|-------------------|--------|
| 44 | BALL VALVE | "T"/"L" PORT 3-WAY MONOBLOCK | SF11 | REDUCED BORE | PN16 PN25/40 ANSI 150 ANSI 300 | - | FROM 1/2" TO 2" | FLANGED | - |
| MATERIAL | | SEATS | | SPECIAL EXECUTIONS | | | | | |
| STAINLESS STEEL 316 STEEL A105 | | PTFE PTFE+GLASS PTFE + CARBONGRAPHITE DELTRIN PEEK KEL-F DEVLON | | STAINLESS STEEL LEVERS AND BOLTS STEM EXTENSION PADLOCKING DEVICES OVAL HANDWHEELS CONSTRUCTION FOR ACTUATOR OPERATION SEAL WELDING FULLY WELDING COMBINED CONNECTIONS (EX.BSP- F/SW) DEGREASING FOR OXYGEN USE TAILOR-MADE LENGTH PERSONALIZED MARKING SINGLE PRODUCT PACKAGING 1/8" DIAMETER REALIZATION SEATS AND GASKETS ON SPECIFIC REQUEST | | | | | |
| | | | | | | | | | |



NEEDLE VALVES

| POS/PG | TYPE | CLASSIFICATION | DRAWING CODE | FLUID PASSAGE SPECIFICATION | PRESSURE CLASS (LBS) | PRESSURE CLASS (PSI) | DIAMETERS | CONNECTIONS/ ENDS | THREAD |
|---|--------------|--|--------------|--|----------------------|----------------------|-----------------|---------------------|--------|
| 45 | NEEDLE VALVE | STRAIGHT WAY | SP01 | - | 1500 | 3000 | FROM 1/4" TO 2" | NPT BSPP BSPT | F/F |
| MATERIAL | | SEATS | | SPECIAL EXECUTIONS | | | | | |
| STAINLESS STEEL 316 STEEL LF2 STEEL A105 STEEL F51 | | BODY/BONNET: ASBESTOS-FREE NON METALLIC GASKET PACKING: TEFLON COATED COTTON | | STAINLESS STEEL/CARBON STEEL T-BAR HANDLE BAKELITE HANDWHEEL PADLOCKING DEVICES COMBINED CONNECTIONS (EX.BSP- F/SW) DEGREASING FOR OXYGEN USE TAILOR-MADE LENGTH WITH DRAIN SS 316 TRIM GRAPHITE OR PTFE PACKING 1/8" DIAMETER REALIZATION PERSONALIZED MARKING SINGLE PRODUCT PACKAGING WELDED BONNET PINS - LOCKED BONNET PRESSED NEEDLE | | | | | |
|  | | | | | | | | | |

| POS/PG | TYPE | CLASSIFICATION | DRAWING CODE | FLUID PASSAGE SPECIFICATION | PRESSURE CLASS (LBS) | PRESSURE CLASS (PSI) | DIAMETERS | CONNECTIONS/ ENDS | THREAD |
|---|--------------|--|--------------|--|----------------------|----------------------|---------------------|---------------------|--------|
| 46 | NEEDLE VALVE | STRAIGHT WAY | SP02 | - | 2500 | 6000 | FROM 1/4" TO 1 1/2" | NPT BSPP BSPT | F/F |
| MATERIAL | | SEATS | | SPECIAL EXECUTIONS | | | | | |
| STAINLESS STEEL 316 STEEL LF2 STEEL A105 STEEL F51 | | BODY/BONNET: ASBESTOS-FREE NON METALLIC GASKET PACKING: TEFLON COATED COTTON | | STAINLESS STEEL/CARBON STEEL T-BAR HANDLE BAKELITE HANDWHEEL PADLOCKING DEVICES COMBINED CONNECTIONS (EX.BSP- F/SW) DEGREASING FOR OXYGEN USE TAILOR-MADE LENGTH WITH DRAIN SS 316 TRIM GRAPHITE OR PTFE PACKING 1/8" DIAMETER REALIZATION PERSONALIZED MARKING SINGLE PRODUCT PACKAGING WELDED BONNET PINS - LOCKED BONNET PRESSED NEEDLE | | | | | |
|  | | | | | | | | | |

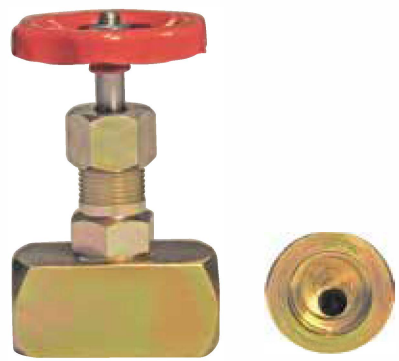
| POS/PG | TYPE | CLASSIFICATION | DRAWING CODE | FLUID PASSAGE SPECIFICATION | PRESSURE CLASS (LBS) | PRESSURE CLASS (PSI) | DIAMETERS | CONNECTIONS/ ENDS | THREAD |
|---|--------------|--|--------------|--|----------------------|----------------------|-----------------|-------------------|--------|
| 47 | NEEDLE VALVE | STRAIGHT WAY | SP01.SW | - | 1500 | 3000 | FROM 1/4" TO 2" | SW | - |
| MATERIAL | | SEATS | | SPECIAL EXECUTIONS | | | | | |
| STAINLESS STEEL 316 STEEL LF2 STEEL A105 STEEL F51 | | BODY/BONNET: ASBESTOS-FREE NON METALLIC GASKET PACKING: TEFLON COATED COTTON | | STAINLESS STEEL/CARBON STEEL T-BAR HANDLE BAKELITE HANDWHEEL PADLOCKING DEVICES COMBINED CONNECTIONS (EX.BSP- F/SW) DEGREASING FOR OXYGEN USE TAILOR-MADE LENGTH WITH DRAIN SS 316 TRIM GRAPHITE OR PTFE PACKING 1/8" DIAMETER REALIZATION PERSONALIZED MARKING SINGLE PRODUCT PACKAGING WELDED BONNET PINS - LOCKED BONNET PRESSED NEEDLE | | | | | |
|  | | | | | | | | | |

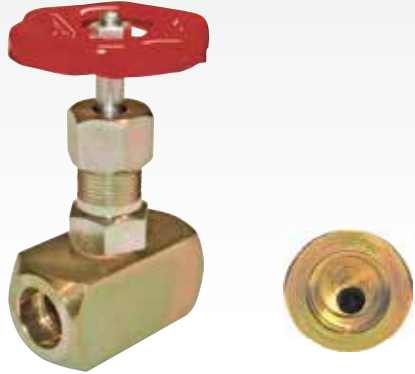

NEEDLE VALVES

| POS/PG | TYPE | CLASSIFICATION | DRAWING CODE | FLUID PASSAGE SPECIFICATION | PRESSURE CLASS (LBS) | PRESSURE CLASS (PSI) | DIAMETERS | CONNECTIONS/ ENDS | THREAD | |
|---|--------------|--|--------------|--|----------------------|----------------------|---|-------------------|--------|--|
| 48 | NEEDLE VALVE | STRAIGHT WAY | SP02.SW | - | 2500 | 6000 | FROM 1/4" TO 1 1/2" | SW | - | |
| MATERIAL | | SEATS | | SPECIAL EXECUTIONS | | |  | | | |
| STAINLESS STEEL 316 STEEL LF2 STEEL A105 STEEL F51 | | BODY/BONNET: ASBESTOS-FREE NON METALLIC GASKET PACKING: TEFLON COATED COTTON | | STAINLESS STEEL/CARBON STEEL T-BAR HANDLE BAKELITE HANDWHEEL PADLOCKING DEVICES COMBINED CONNECTIONS (EX.BSP- F/SW) DEGREASING FOR OXYGEN USE TAILOR-MADE LENGTH WITH DRAIN SS 316 TRIM GRAPHITE OR PTFE PACKING 1/8" DIAMETER REALIZATION PERSONALIZED MARKING SINGLE PRODUCT PACKAGING WELDED BONNET PINS - LOCKED BONNET PRESSED NEEDLE | | | | | | |

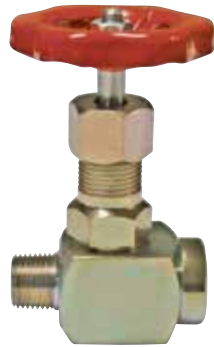
| POS/PG | TYPE | CLASSIFICATION | DRAWING CODE | FLUID PASSAGE SPECIFICATION | PRESSURE CLASS (LBS) | PRESSURE CLASS (PSI) | DIAMETERS | CONNECTIONS/ ENDS | THREAD | |
|---|--------------|--|--------------|--|----------------------|----------------------|---|---------------------|--------|--|
| 49 | NEEDLE VALVE | STRAIGHT WAY | SP05 | - | 1500 | 3000 | FROM 1/4" TO 2" | NPT BSPP BSPT | M/F | |
| MATERIAL | | SEATS | | SPECIAL EXECUTIONS | | |  | | | |
| STAINLESS STEEL 316 STEEL LF2 STEEL A105 STEEL F51 | | BODY/BONNET: ASBESTOS-FREE NON METALLIC GASKET PACKING: TEFLON COATED COTTON | | STAINLESS STEEL/CARBON STEEL T-BAR HANDLE BAKELITE HANDWHEEL PADLOCKING DEVICES COMBINED CONNECTIONS (EX.BSP- M/SW) DEGREASING FOR OXYGEN USE TAILOR-MADE LENGTH WITH DRAIN SS 316 TRIM GRAPHITE OR PTFE PACKING 1/8" DIAMETER REALIZATION PERSONALIZED MARKING SINGLE PRODUCT PACKAGING WELDED BONNET PINS - LOCKED BONNET PRESSED NEEDLE | | | | | | |

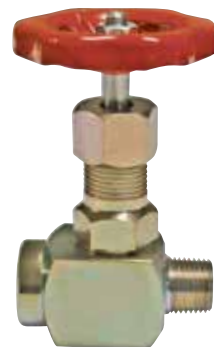
| POS/PG | TYPE | CLASSIFICATION | DRAWING CODE | FLUID PASSAGE SPECIFICATION | PRESSURE CLASS (LBS) | PRESSURE CLASS (PSI) | DIAMETERS | CONNECTIONS/ ENDS | THREAD | |
|---|--------------|--|--------------|--|----------------------|----------------------|---|---------------------|--------|--|
| 50 | NEEDLE VALVE | STRAIGHT WAY | SP07 | - | 2500 | 6000 | FROM 1/4" TO 1 1/2" | NPT BSPP BSPT | M/F | |
| MATERIAL | | SEATS | | SPECIAL EXECUTIONS | | |  | | | |
| STAINLESS STEEL 316 STEEL LF2 STEEL A105 STEEL F51 | | BODY/BONNET: ASBESTOS-FREE NON METALLIC GASKET PACKING: TEFLON COATED COTTON | | STAINLESS STEEL/CARBON STEEL T-BAR HANDLE BAKELITE HANDWHEEL PADLOCKING DEVICES COMBINED CONNECTIONS (EX.BSP- M/SW) DEGREASING FOR OXYGEN USE TAILOR-MADE LENGTH WITH DRAIN SS 316 TRIM GRAPHITE OR PTFE PACKING 1/8" DIAMETER REALIZATION PERSONALIZED MARKING SINGLE PRODUCT PACKAGING WELDED BONNET PINS - LOCKED BONNET PRESSED NEEDLE | | | | | | |



NEEDLE VALVES

| POS/PG | TYPE | CLASSIFICATION | DRAWING CODE | FLUID PASSAGE SPECIFICATION | PRESSURE CLASS (LBS) | PRESSURE CLASS (PSI) | DIAMETERS | CONNECTIONS/ ENDS | THREAD |
|---|--------------|--|--------------|---|----------------------|----------------------|-----------------|---------------------|--------|
| 51 | NEEDLE VALVE | STRAIGHT WAY | SP11 | - | 1500 | 3000 | FROM 1/4" TO 2" | NPT BSPP BSPT | M/M |
| MATERIAL | | SEATS | | SPECIAL EXECUTIONS | | | | | |
| STAINLESS STEEL 316 STEEL LF2 STEEL A105 STEEL F51 | | BODY/BONNET: ASBESTOS-FREE NON METALLIC GASKET PACKING: TEFLON COATED COTTON | | STAINLESS STEEL/CARBON STEEL T-BAR HANDLE BAKELITE HANDWHEEL PADLOCKING DEVICES DEGREASING FOR OXYGEN USE TAILOR-MADE LENGTH WITH DRAIN SS 316 TRIM GRAPHITE OR PTFE PACKING 1/8" DIAMETER REALIZATION PERSONALIZED MARKING SINGLE PRODUCT PACKAGING WELDED BONNET PINS - LOCKED BONNET PRESSED NEEDLE | | | | | |
|  | | | | | | | | | |

| POS/PG | TYPE | CLASSIFICATION | DRAWING CODE | FLUID PASSAGE SPECIFICATION | PRESSURE CLASS (LBS) | PRESSURE CLASS (PSI) | DIAMETERS | CONNECTIONS/ ENDS | THREAD |
|---|--------------|--|--------------|---|----------------------|----------------------|---------------------|---------------------|--------|
| 52 | NEEDLE VALVE | STRAIGHT WAY | SP11.6000 | - | 2500 | 6000 | FROM 1/4" TO 1 1/2" | NPT BSPP BSPT | M/M |
| MATERIAL | | SEATS | | SPECIAL EXECUTIONS | | | | | |
| STAINLESS STEEL 316 STEEL LF2 STEEL A105 STEEL F51 | | BODY/BONNET: ASBESTOS-FREE NON METALLIC GASKET PACKING: TEFLON COATED COTTON | | STAINLESS STEEL/CARBON STEEL T-BAR HANDLE BAKELITE HANDWHEEL PADLOCKING DEVICES DEGREASING FOR OXYGEN USE TAILOR-MADE LENGTH WITH DRAIN SS 316 TRIM GRAPHITE OR PTFE PACKING 1/8" DIAMETER REALIZATION PERSONALIZED MARKING SINGLE PRODUCT PACKAGING WELDED BONNET PINS - LOCKED BONNET PRESSED NEEDLE | | | | | |
|  | | | | | | | | | |

| POS/PG | TYPE | CLASSIFICATION | DRAWING CODE | FLUID PASSAGE SPECIFICATION | PRESSURE CLASS (LBS) | PRESSURE CLASS (PSI) | DIAMETERS | CONNECTIONS/ ENDS | THREAD |
|---|--------------|--|--------------|---|----------------------|----------------------|-----------------|-------------------|--------|
| 53 | NEEDLE VALVE | STRAIGHT WAY | SP09 | - | 1500 | 3000 | FROM 1/4" TO 2" | BW | |
| MATERIAL | | SEATS | | SPECIAL EXECUTIONS | | | | | |
| STAINLESS STEEL 316 STEEL LF2 STEEL A105 STEEL F51 | | BODY/BONNET: ASBESTOS-FREE NON METALLIC GASKET PACKING: TEFLON COATED COTTON | | STAINLESS STEEL/CARBON STEEL T-BAR HANDLE BAKELITE HANDWHEEL PADLOCKING DEVICES COMBINED CONNECTIONS (EX. BSP- F/BW) DEGREASING FOR OXYGEN USE TAILOR-MADE LENGTH WITH DRAIN SS 316 TRIM GRAPHITE OR PTFE PACKING 1/8" DIAMETER REALIZATION PERSONALIZED MARKING SINGLE PRODUCT PACKAGING WELDED BONNET PINS - LOCKED BONNET PRESSED NEEDLE | | | | | |
|  | | | | | | | | | |



NEEDLE VALVES

| POS/PG | TYPE | CLASSIFICATION | DRAWING CODE | FLUID PASSAGE SPECIFICATION | PRESSURE CLASS (LBS) | PRESSURE CLASS (PSI) | DIAMETERS | CONNECTIONS/ ENDS | THREAD |
|---|--------------|--|--------------|--|----------------------|----------------------|---------------------|-------------------|--------|
| 54 | NEEDLE VALVE | STRAIGHT WAY | SP09.6000 | - | 2500 | 6000 | FROM 1/4" TO 1 1/2" | BW | - |
| MATERIAL | | SEATS | | SPECIAL EXECUTIONS | | | | | |
| STAINLESS STEEL 316 STEEL LF2 STEEL A105 STEEL F51 | | BODY/BONNET: ASBESTOS-FREE NON METALLIC GASKET PACKING: TEFLON COATED COTTON | | STAINLESS STEEL/CARBON STEEL T-BAR HANDLE BAKELITE HANDWHEEL PADLOCKING DEVICES COMBINED CONNECTIONS (EX.BSP- F/SW) DEGREASING FOR OXYGEN USE TAILOR-MADE LENGTH WITH DRAIN SS 316 TRIM GRAPHITE OR PTFE PACKING 1/8" DIAMETER REALIZATION PERSONALIZED MARKING SINGLE PRODUCT PACKAGING WELDED BONNET PINS - LOCKED BONNET PRESSED NEEDLE | | | | | |
|  | | | | | | | | | |

| POS/PG | TYPE | CLASSIFICATION | DRAWING CODE | FLUID PASSAGE SPECIFICATION | PRESSURE CLASS (LBS) | PRESSURE CLASS (PSI) | DIAMETERS | CONNECTIONS/ ENDS | THREAD |
|---|--------------|--|--------------|--|----------------------|----------------------|-----------------|-------------------|--------|
| 55 | NEEDLE VALVE | STRAIGHT WAY | SP.PN16 | - | PN16 | - | FROM 1/4" TO 2" | FLANGED | - |
| MATERIAL | | SEATS | | SPECIAL EXECUTIONS | | | | | |
| STAINLESS STEEL 316 STEEL LF2 STEEL A105 STEEL F51 | | BODY/BONNET: ASBESTOS-FREE NON METALLIC GASKET PACKING: TEFLON COATED COTTON | | STAINLESS STEEL/CARBON STEEL T-BAR HANDLE BAKELITE HANDWHEEL PADLOCKING DEVICES COMBINED CONNECTIONS (EX.BSP- F/SW) DEGREASING FOR OXYGEN USE TAILOR-MADE LENGTH WITH DRAIN SS 316 TRIM GRAPHITE OR PTFE PACKING 1/8" DIAMETER REALIZATION PERSONALIZED MARKING SINGLE PRODUCT PACKAGING WELDED BONNET PINS - LOCKED BONNET PRESSED NEEDLE | | | | | |
|  | | | | | | | | | |

| POS/PG | TYPE | RIGHT ANGLE | DRAWING CODE | FLUID PASSAGE SPECIFICATION | PRESSURE CLASS (LBS) | PRESSURE CLASS (PSI) | DIAMETERS | CONNECTIONS/ ENDS | THREAD |
|---|--------------|--|--------------|--|----------------------|----------------------|-----------------|---------------------|--------|
| 56 | NEEDLE VALVE | 90° /RIGHT ANGLE | SP90 | - | 1500 | 3000 | FROM 1/4" TO 2" | NPT BSPP BSPT | F/F |
| MATERIAL | | SEATS | | SPECIAL EXECUTIONS | | | | | |
| STAINLESS STEEL 316 STEEL LF2 STEEL A105 STEEL F51 | | BODY/BONNET: ASBESTOS-FREE NON METALLIC GASKET PACKING: TEFLON COATED COTTON | | STAINLESS STEEL/CARBON STEEL T-BAR HANDLE BAKELITE HANDWHEEL PADLOCKING DEVICES COMBINED CONNECTIONS (EX.BSP- F/FW) DEGREASING FOR OXYGEN USE TAILOR-MADE LENGTH WITH DRAIN SS 316 TRIM GRAPHITE OR PTFE PACKING 1/8" DIAMETER REALIZATION PERSONALIZED MARKING SINGLE PRODUCT PACKAGING WELDED BONNET PINS - LOCKED BONNET PRESSED NEEDLE M/F THREADS COMBINATIONS | | | | | |
|  | | | | | | | | | |



CHECK VALVES

| POS/PG | TYPE | CLASSIFICATION | DRAWING CODE | FLUID PASSAGE SPECIFICATION | PRESSURE CLASS (LBS) | PRESSURE CLASS (PSI) | DIAMETERS | CONNECTIONS/ ENDS | THREAD |
|-----------------------------------|-------------|--|--------------|---|-----------------------|----------------------|---------------------|---------------------|--------|
| 57 | CHECK VALVE | WITH SPRING | RT01 | - | PN16 PN64 PN100 | - | FROM 1/2" TO 2 1/2" | NPT BSPP BSPT | F/F |
| MATERIAL | | SEATS | | SPECIAL EXECUTIONS | | | | | |
| STAINLESS STEEL 316 STEEL A105 | | PTFE VITON PTFE + CARBONGRAPHITE METAL SEAL | | DEGREASING FOR OXYGEN USE PERSONALIZED MARKING SINGLE PRODUCT PACKAGING | | | | | |
| | | | | | | | | | |

| POS/PG | TYPE | CLASSIFICATION | DRAWING CODE | FLUID PASSAGE SPECIFICATION | PRESSURE CLASS (LBS) | PRESSURE CLASS (PSI) | DIAMETERS | CONNECTIONS/ ENDS | THREAD |
|-----------------------------------|-------------|-------------------------------|--------------|---|----------------------|----------------------|-------------------|---------------------|--------|
| 58 | CHECK VALVE | WITH SPRING HEXAGONAL TYPE | RT01.ES | - | PN25 | - | FROM 1/4" TO 3/8" | NPT BSPP BSPT | F/F |
| MATERIAL | | SEATS | | SPECIAL EXECUTIONS | | | | | |
| STAINLESS STEEL 316 STEEL A105 | | PTFE | | DEGREASING FOR OXYGEN USE PERSONALIZED MARKING SINGLE PRODUCT PACKAGING | | | | | |
| | | | | | | | | | |

| POS/PG | TYPE | CLASSIFICATION | DRAWING CODE | FLUID PASSAGE SPECIFICATION | PRESSURE CLASS (LBS) | PRESSURE CLASS (PSI) | DIAMETERS | CONNECTIONS/ ENDS | THREAD |
|-----------------------------------|-------------|--|--------------|---|-----------------------|----------------------|---------------------|-------------------|--------|
| 59 | CHECK VALVE | SPRING | RT01 | - | PN16 PN64 PN100 | - | FROM 1/2" TO 2 1/2" | SW | - |
| MATERIAL | | SEATS | | SPECIAL EXECUTIONS | | | | | |
| STAINLESS STEEL 316 STEEL A105 | | PTFE VITON PTFE + CARBONGRAPHITE METAL SEAL | | DEGREASING FOR OXYGEN USE PERSONALIZED MARKING SINGLE PRODUCT PACKAGING | | | | | |
| | | | | | | | | | |



TEVAL
TECHNICAL VALVES

PRESSURE-GAUGE NEEDLE VALVE

| POS/ PG | TYPE | CLASSIFICATION | DRAWING CODE | FLUID PASSAGE SPECIFICATION | PRESSURE CLASS (LBS) | PRESSURE CLASS (PSI) | DIAMETERS | CONNECTIONS/ ENDS | THREAD |
|-----------------------------------|--------------------------------|--|-----------------|--|----------------------------|---|-------------------|----------------------|--------|
| 60 | PRESSURE GAUGE NEEDLE VALVE | STRAIGHT WAY | PO01 | - | 1500 | 3000 | FROM 1/4" TO 1/2" | NPT BSPP BSPT | M/F |
| MATERIAL | | SEATS | | SPECIAL EXECUTIONS | |  | | | |
| STAINLESS STEEL 316 STEEL A105 | | BODY/BONNET: ASBESTOS-FREE NON METALLIC GASKET PACKING: TEFLON COATED COTTON | | STAINLESS STEEL/IRON BAR HANDWHEEL BAKELITE HANDWHEEL PADLOCKING DEVICES F/F END DEGREASING FOR OXYGEN USE TAILOR-MADE LENGTH WITH DRAIN STAINLESS STEEL 316 TRIM GRAPHITE OR PTFE PACKING 1/8" DIAMETER REALIZATION 2500 LBS - 6000 PSI RATINGS PERSONALIZED MARKING SINGLE PRODUCT PACKAGING | | | | | |

| POS/ PG | TYPE | CLASSIFICATION | DRAWING CODE | FLUID PASSAGE SPECIFICATION | PRESSURE CLASS (LBS) | PRESSURE CLASS (PSI) | DIAMETERS | CONNECTIONS/ ENDS | THREAD |
|-----------------------------------|--------------------------------|--|-----------------|--|----------------------------|---|-------------------|----------------------|--------|
| 61 | PRESSURE GAUGE NEEDLE VALVE | STRAIGHT WAY 2-WAY PATTERN WITH DRAIN | PO02 | - | 1500 | 3000 | FROM 1/4" TO 1/2" | NPT BSPP BSPT | M/F |
| MATERIAL | | SEATS | | SPECIAL EXECUTIONS | |  | | | |
| STAINLESS STEEL 316 STEEL A105 | | BODY/BONNET: ASBESTOS-FREE NON METALLIC GASKET PACKING: TEFLON COATED COTTON | | STAINLESS STEEL/IRON BAR HANDWHEEL BAKELITE HANDWHEEL PADLOCKING DEVICES F/F END DEGREASING FOR OXYGEN USE TAILOR-MADE LENGTH WITH DRAIN STAINLESS STEEL 316 TRIM GRAPHITE OR PTFE PACKING 1/8" DIAMETER REALIZATION 2500 LBS - 6000 PSI RATINGS PERSONALIZED MARKING SINGLE PRODUCT PACKAGING | | | | | |

| POS/ PG | TYPE | CLASSIFICATION | DRAWING CODE | FLUID PASSAGE SPECIFICATION | PRESSURE CLASS (LBS) | PRESSURE CLASS (PSI) | DIAMETERS | CONNECTIONS/ ENDS | THREAD |
|-----------------------------------|--------------------------------|--|-----------------|--|----------------------------|---|-------------------|----------------------|--------|
| 62 | PRESSURE GAUGE NEEDLE VALVE | STRAIGHTWAY 3-WAY PATTERN WITH DRAIN AND CONTROL FLANGE | PO03 | - | 1500 | 3000 | FROM 1/4" TO 1/2" | NPT BSPP BSPT | M/F |
| MATERIAL | | SEATS | | SPECIAL EXECUTIONS | |  | | | |
| STAINLESS STEEL 316 STEEL A105 | | BODY/BONNET: ASBESTOS-FREE NON METALLIC GASKET PACKING: TEFLON COATED COTTON | | STAINLESS STEEL/IRON BAR HANDWHEEL BAKELITE HANDWHEEL PADLOCKING DEVICES F/F END DEGREASING FOR OXYGEN USE TAILOR-MADE LENGTH WITH DRAIN STAINLESS STEEL 316 TRIM GRAPHITE OR PTFE PACKING 1/8" DIAMETER REALIZATION 2500 LBS - 6000 PSI RATINGS PERSONALIZED MARKING SINGLE PRODUCT PACKAGING | | | | | |



TEVAL steht Ihnen jederzeit zur Verfügung, um maßgeschneiderte Kostenvoranschläge zu erstellen. Die gesamte Produktion erfolgt nach den besonderen Bedürfnissen des Kunden unter Verwendung der am besten geeigneten Materialien, die in den technischen Spezifikationen verlangt werden.

*TEVAL is at your complete disposal to provide customized estimates.
All production is performed according to the particular needs of the Client using the most suitable materials required in the technical specifications.*